

Produktkatalog 2022



 KONTAKT simon
PRODUKTKATALOG
2022

KONTAKT simon

FÖRETAGSSTRUKTUR

KONTAKT simon

SIMON ÄR EN TILLVERKARE AV INSTALLATIONSMATERIEL, MED EN HISTORIA SOM STARTADE REDAN 1916.

IDAG UTVECKLAR SIMON PRODUKTER BÅDE I SPANIEN OCH POLEN.

SIMON HAR EN STOR UTVECKLINGSAVDELNING, DEDIKERAD FÖR ATT HITTA DE BÄSTA LÖSNINGARNA SOM STÅR TILL BUDS.

INNOVATION, DESIGN, QUALITY AND TRUST ÄR LEDORDEN FÖR SIMON.

DETTA GÖR ATT SIMON KLARAR AV ATT PRODUCERA, INTE BARA ESTETISKT, UNIVERSELLA OCH SÄKRA PRODUKTER, MEN OCKSÅ VARA I FRAMKANT GÄLLANDE UTVECKLING OCH MILJÖ.



simon
H O L D I N G

Barcelona, Spanien

SIMON HOLDING: DET SOM BÖRjade SOM EN LITEN FAMILJE VERKSTAD I SPANIEN FÖR NÄSTAN HUNDRA ÅR SEDAN, ÄR IDAG ETT FÖRETAG MED 25 DOTTERBOLAG SPRIDDA ÖVER HELA VÄRLDEN. DETTA TA CK VARE HÄRT ARBETE, ENGAGEMANG FÖR KVALITET OCH ANPASSNINGSFÖRMÅGA TILL NYA MARKNADER.

SIMON ÄR FORTFARANDE I FAMILJENS ÄGO (FJÄRDE GENERATIONEN) OCH HANTERAS FRÅN HUVUDKONTORET I BARCELONA.

Simon54
LISTA 13

Simon54
LISTA 18

Simon54
LISTA 51

 KONTAKT simon

Simon54
LISTA 60

Simon54
LISTA 62

Simon54
LISTA 85

Simon 54 *Premium*

SIMON 54 PREMIUM ÄR EN KOMBINATION AV ORIGINELL DESIGN OCH FUNKTIONALITET. I SERIEN INGÅR STRÖMBRYTARE OCH VÄGGUTTAG, SAMT TEKNIKPRODUKTER SOM DIMMER, TIMER, OCH OLIKA UTTAG FÖR T.EX. HDMI. ALLA PRODUKTER ÄR KOMPATIBLA MED SIMONS DESIGNRAMAR MED OLIKA FÄRG OCH FORM.



Simon 54 LOFT

UTANPÄLIGGANDE BRYTARSERIE
KONTAKTSIMONS UTANPÄLIGGANDE STRÖM-
BRYTARE ÄR DESIGNADE I SAMMA STIL SOM VÅR
INFÄLLDA SERIE "PREMIUM". BRYTAREN TÄCKER
VANLIG VÄGGDOSA OCH PASSAR I OCH MED DETTA
UTMÄRKT PÅ ALLA TYPER AV JOBB. BRYTAREN KAN
FÅS I ALLA TRE STANDARDFÄRGERNA: VIT, ALU,
ANTRACIT.



Simon 54

























NATURE

SIMON 54 NATURE, MED DESIGN I FOKUS. ELEGANTA RAMAR I TRÄ, GLAS ELLER METALL, SOM KAN TILLFREDSSTÄLLA ALLA STILAR. KAN ANPASSAS BÅDE TILL MODERNA OCH TRADITIONELLA INSTALLATIONER, ÄVEN OM DU BARA VILL FRAMHÄVA DIN PERSONLIGA STIL.

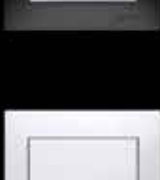

Simon 54

Premium

	<i>vit</i>	<i>alu</i>	<i>antracit</i>
RAM			
<i>metal chrome</i>			
<i>metal inox</i>			
<i>dark steel</i>			
<i>metal copper</i>			
<i>alu</i>			
<i>antracit</i>			
<i>vit</i>			

BETONGRAMAR

Light concrete/white
DRN1/91



Light concrete/alu
DRN1/92



Light concrete/anthracite
DRN1/93



Dark concrete/white
DRN1/95



Dark concrete/alu
DRN1/96



Dark concrete/anthracite
DRN1/97



GLASRAMAR

White Pearl
DRN1/70



Lime Sorbet
DRN1/90



Lunar Lava
DRN1/74



Frozen Lava
DRN1/73



Silver Fog
DRN1/71



Tempting Plum
DRN1/89



Stormy Cloud
DRN1/72



STÅLRAMAR

Satin Glare
DRN1/79



Satin Dusk
DRN1/80



Classic Inox
DRN1/77



Inox Yin
DRN1/78



Inox Yang
DRN1/76



TRÄRAM

Silver Wenge
DRN1/84



Märkningen på baksidan visar sladdens optimala isoleringslängd.



Märkningen på baksidan indikerar optimal avisolation

Enkel och snabb montering av ram, leder till tidsvinster för installatören.

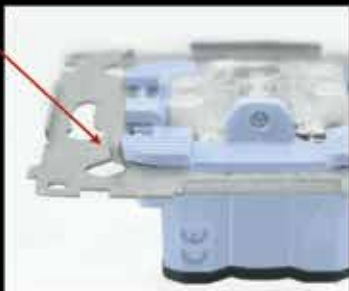

Små kompakta mekanismer, vilket frigör utrymme i dosan.



Stålpattan har en lip, vilket gör det enkelt att montera mekanismen i rätt nivå.

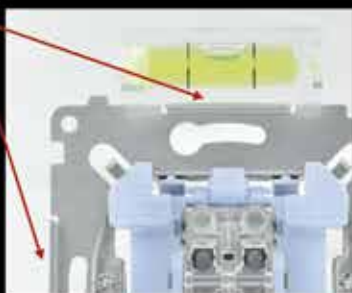

Spår i stålramen gör det enkelt att montera flera enheter i kombinationsram.

Kan installeras utan apparatdosa, med hjälp av för-borrade hål i hörnen av stålplattan.

Stålpattan är härdad, och garanterar en stabil installation.

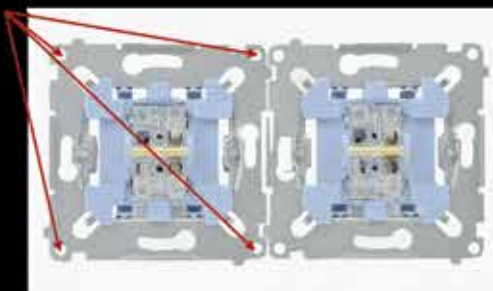

Simon54

Ramar 1-5 håls används vertikalt eller horisontellt.

Miljövänlig, UV beständig polycarbonat för säker och stabil funktion.

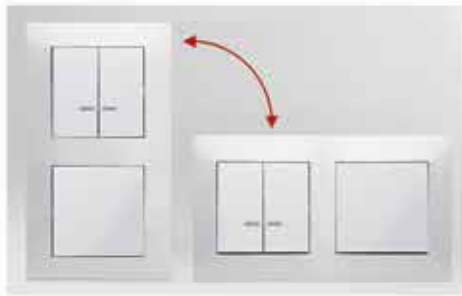

Blå LED-belysning

Alla ramar kan enkelt uppgraderas till IP44 med användning av tätningssats.



Alla produkter kan fås förseglade individuellt. Skyddar produkten från smuts och repor, hela vägen till montering.





LISTA 13



DIMMER LISTA 13



13 775 70 Dimmer för glödlampor, 230 halogen, el trafo och LED-ljuskällor från 20 Transistordimmer för softstart. Bakkantstyrd dimmer för elektronisk transformator. Kan kopplas med trappfunktion 20-500 W

10 Vit

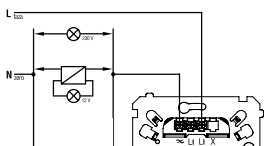
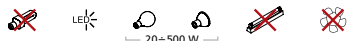

13 775 72 230 LED Dimmer med reglerbart minimum-nivå. Dimern har 2-polig strömställare. 5-215W

10 Vit



13 775 71 2-pol dimmer för glödlampor, 230 halogen, och utvalda LED ljuskällor. Bakkantdimring 20-315W Vridstart. Ej Trapp.

10 Vit

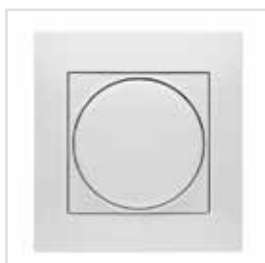
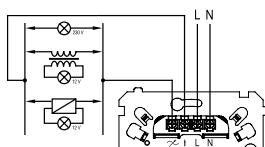
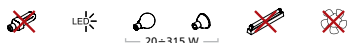





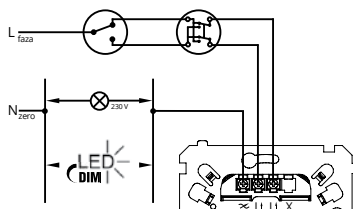
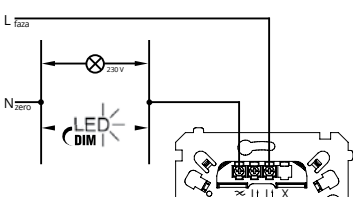



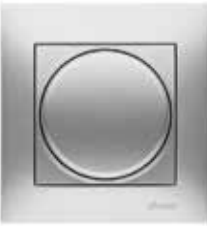





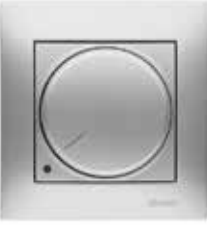





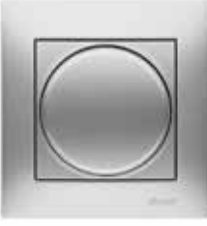





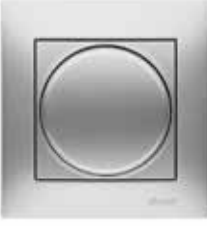

























13 604 45 Dimmer LED m trappfunktion 250W LED







10 Vit



Kontakt-Simon dimmer guide							
Produkt	El nummer	Typ	Brytare	Säkring	Ohmsk last Glödlampa	230V Halogen	El.trafo 230/12V
DS9TC	13 775 70	Transistor Bakkantdim- mer	Vred /Tryck Trappfunktion	Elektronisk	20-500W	20-500W	20-500W
	13 775 74						
	13 775 78						
DS9L2	13 775 72	LED	2 pol vred av/på	Elektronisk	5-215W	X	X
	13 775 76						
	13 775 78						
DS9LE	13 604 45	LED 2-250W	Vred / tryck trappfunktion	Elektronisk	2-250W	5-250W	15-250W
	13 604 46						
	13 604 47						

E-nr	Beskrivning	Förp.	Färg
	13 775 74 Dimmer 20-500W el.trafo-230V halogen       — 20+500 W —	10	Alu
	13 775 76 Dimmer LED 2-pol       — 20+315 W —	10	Alu
	13 775 75 2-pol dimmer för glödlampor, 230 halogen, och utvalda LED ljuskällor. Bakkantdimming 20-315W Vridstart.      	10	Alu
	13 604 46 Dimmer LED m trappfunktion 250W LED      	10	Alu
	13 775 78 Dimmer 20-500W el.trafo-230V halogen       — 20+500 W —	10	Antracit
	13 775 80 Dimmer LED 2-pol       — 20+315 W —	10	Antracit
	13 775 79 2-pol dimmer för glödlampor, 230 halogen, och utvalda LED ljuskällor. Bakkantdimming 20-315W Vridstart.      	10	Antracit
	13 604 47 Dimmer LED m trappfunktion 250W LED      	10	Antracit

RÖRELSESVAKT, PIR LISTA 13

	<p>13 167 20 Rörelsesvakt auto max 2000W För offentliga miljöer/installation. Kan ej förbikopplas. Justerbar Lux sensitivitet. Tidsinställning: 5 sek.-21 min. Max 7 m. 110°</p>	8	Vit
	<p>13 167 21 Rörelsesvakt m/brytare max 2000W För privata hem. Kan enkelt förbikopplas med tryck knapp. Justerbar Lux sensitivitet. Tidsinställning: 5 sek.-21 min. Max 7 m. 110°</p>	4	Vit
	<p>13 167 22 Rörelsesvakt auto max 2000W För offentliga miljöer/installation. Kan ej förbikopplas. Justerbar Lux sensitivitet. Tidsinställning: 5 sek.-21 min. Max 7 m. 110°</p>	4	Alu
	<p>13 167 23 Rörelsesvakt m/brytare max 2000W För privata hem. Kan enkelt förbikopplas med tryck knapp. Justerbar Lux sensitivitet. Tidsinställning: 5 sek.-21 min. Max 7 m. 110°</p>	4	Alu
	<p>13 167 24 Rörelsesvakt auto max 2000W För offentliga miljöer/installation. Kan ej förbikopplas. Justerbar Lux sensitivitet. Tidsinställning: 5 sek.-21 min. Max 7 m. 110°</p>	4	Antracit
	<p>13 167 25 Rörelsesvakt m/brytare max 2000W För privata hem. Kan enkelt förbikopplas med tryck knapp. Justerbar Lux sensitivitet. Tidsinställning: 5 sek.-21 min. Max 7 m. 110°</p>	4	Antracit

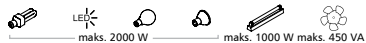

KONTAKT simon







SIDA 18 STRÖMBRYTARE INF SKRUV 16A VIT
SIDA 18 LÖSA KLOR
SIDA 19 STRÖMBRYTARE INF SNABB 16A VIT
SIDA 19 STRÖMBRYTARE INF M/KLOR
SIDA 19 VIPPOR + TILBEHÖR
SIDA 20 STRÖMBRYTARE UTANPÅLIGGANDE SKRUV 16A VIT
SIDA 22 STRÖMBRYTARE INF ALU
SIDA 23 VIPPOR + TILBEHÖR
SIDA 23 STRÖMBRYTARE UTANPÅLIGGANDE SKRUV 16A ALU
SIDA 24 STRÖMBRYTARE INF. ANTRACIT
SIDA 25 VIPPOR + TILBEHÖR
SIDA 25 STRÖMBRYTARE UTANPÅLIGGANDE SKRUV 16A ANTRACIT
SIDA 26 HOTELLKORTS BRYTARE
SIDA 30 VÄGGUTTAG 16A SKRUVANSL./SNABBANSL.
SIDA 31 VÄGGUTTAG 16A UTV.
SIDA 37 VÄGGUTTAG 16A PREMIUM
SIDA 32 FÖRHÖJNINGSRAMAR
SIDA 33 VÄGGUTTAG INF. 16A SKRUVANSL.
SIDA 34 VÄGGUTTAG UTV. 16A SKRUVANSL.
SIDA 35 VÄGGUTTAG 16A PREMIUM
SIDA 35 FÖRHÖJNINGSRAMAR
SIDA 36 VÄGGUTTAG INF. 16A SKRUVANSL.
SIDA 37 VÄGGUTTAG UTV. 16A SKRUVANSL.
SIDA 38 VÄGGUTTAG 16A PREMIUM
SIDA 38 FÖRHÖJNINGSRAMAR
SIDA 39 TIMER
SIDA 40 KOMBINATIONSRAMAR
SIDA 41 SIMON 54 NATURE BETONG RAMAR
SIDA 42 SIMON 54 NATURE GLAS RAMAR
SIDA 43 SIMON 54 NATURE STÅL RAMAR
SIDA 43 SIMON 54 NATURE TRÅ RAM
SIDA 44 DJUPA RAMAR
SIDA 45 IP44 MEMBRAN (FÖR RAMAR)
SIDA 45 BLINDLOCK
SIDA 46 FÖRHÖJNINGSRAMAR

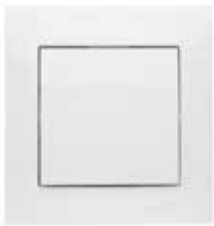

LISTA 18

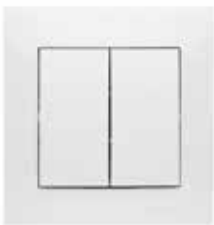
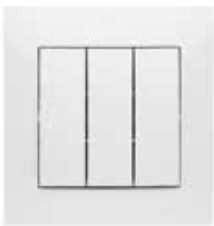

STRÖMBRYTARE INF SKRUV 16A VIT LISTA 18

	18 942 02	1-pol skruv	10	Vit
	18 942 05	Trapp skruv	10	Vit
	18 942 07	Kors skruv	5	Vit
	18 942 08	Impuls skruv	5	Vit
	18 900 19	Branddörrstängning	5	Vit
	18 900 21	Impuls sep. matning 12/24V	5	Vit
	18 942 03	2-pol skruv	10	Vit
	18 942 09	Kron m/1 impuls skruv	5	Vit
	18 942 10	Kron m/dubbel impuls skruv	5	Vit
	18 905 58	Brytare infälld 3x1 pol snabb (Möjlig att få med 3x impuls)	5	Vit
	18 942 11	2+1 skruv	5	Vit
	19 942 12	2+2 skruv	5	Vit

LÖSA KLOR LISTA 18



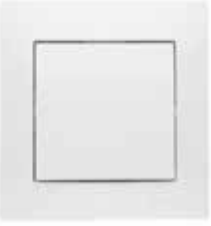
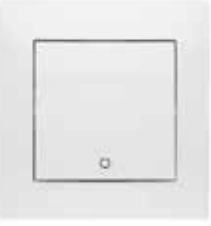
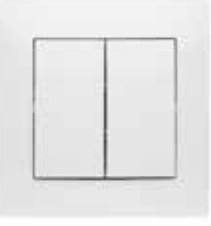
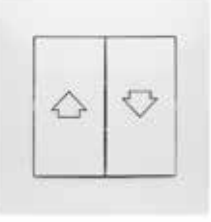

	18 942 20	Lös LED för brytare		
	18 942 22	Lösa klor (10stk par) brytare		
	18 943 76	Impulsfjäder		

STRÖMBRYTARE INF SNABB 16A VIT LISTA 18

STRÖMBRYTARE INF M/KLOR LISTA 18

	18 942 13 1-pol snabb	10	Vit
	18 942 16 Trapp snabb	10	Vit
	18 942 17 Kors snabb	5	Vit
	18 942 18 Impuls snabb	5	Vit
	18 900 23 Impuls m/LED snabb	5	Vit
	18 942 14 2-pol snabb	5	Vit
	18 923 52 Kron snabb 10A	10	Vit
	18 916 69 D-trapp snabb		
*Vid behov av återfjädrande brytare dubbeltrapp, kontakta support.			
	18 942 19 Jalousibrytare snabb	5	Vit

VIPPOR + TILBEHÖR LISTA 18

	18 942 21 Vippa m/fönster		18 943 56 Vippa kron m/fönster
	18 900 24 Vippa m/fönster nyckel		18 900 30 Vippa m/fönster „klocka”
			18 900 33 Vippa m/fönster „ljus”







E-nr

Beskrivning

Förp.

Färg

STRÖMBRYTARE UTANPÅLIGGANDE SKRUV 16A VIT LISTA 18

	<p>18 905 63 Trapp loft utv 18 905 68 Kors Loft utv 18 906 02 Impuls utv</p>	<p>10 5 5</p>	<p>Vit Vit Vit</p>
	<p>18 905 65 Kron Loft utv</p>	<p>5</p>	<p>Vit</p>
	<p>18 905 67 2-pol Loft utv</p>	<p>10</p>	<p>Vit</p>
	<p>18 906 07 Vippa m/nyckel för utanpåliggande brytare</p>	<p>5</p>	<p>Vit</p>
	<p>18 906 08 Vippa m/klocka för utanpåliggande brytare</p>	<p>5</p>	<p>Vit</p>
	<p>18 906 09 Impulsfjäder för utanpåliggande brytare</p>	<p>5</p>	

Anvisning för skruvar till apparatdosa.

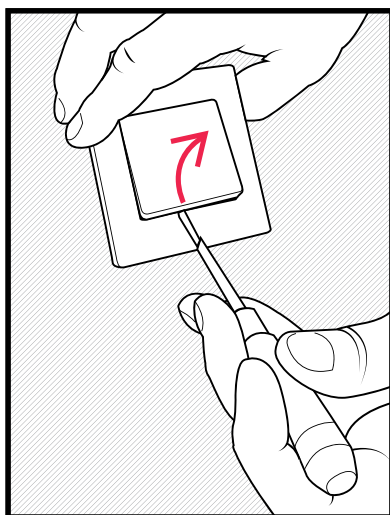
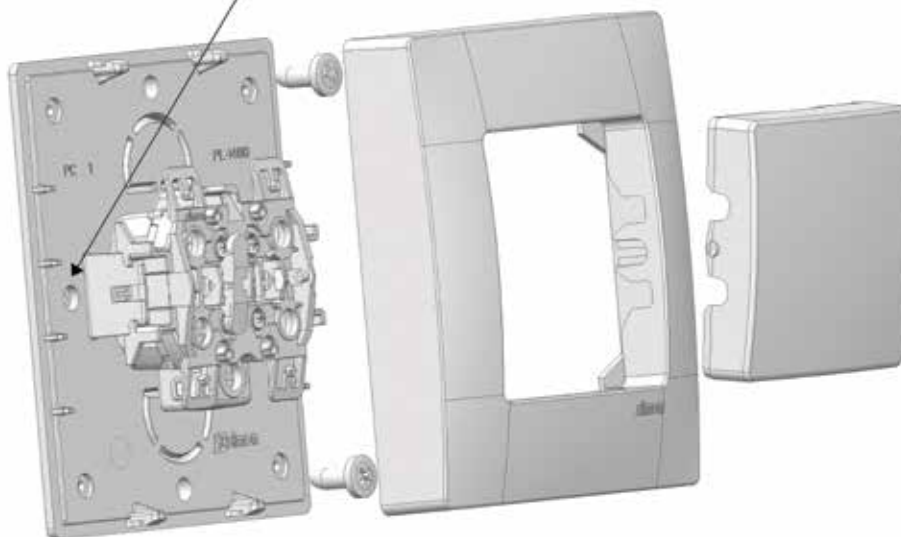

Vippan tas bort.

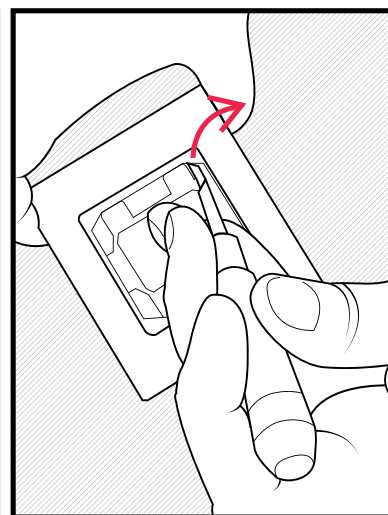
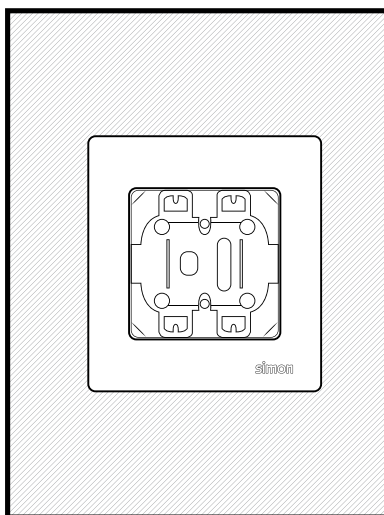

Täckramen tas enkelt bort med en lätt brytning i ett av hörnen.







E-nr

Beskrivning

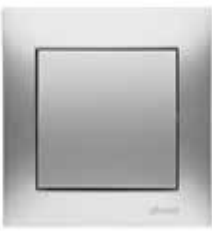
Förp.

Färg

STRÖMBRYTARE INF ALU LISTA 18

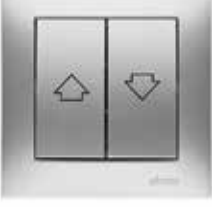

	<p>18 942 25 Trapp skruv 18 942 27 Kors skruv 18 942 28 Impuls skruv</p>	<p>5 5 5</p>	<p>Alu Alu Alu</p>
	<p>18 942 23 2-pol skruv</p>	<p>5</p>	<p>Alu</p>
	<p>18 942 29 Kron m/1 impuls skruv 18 942 30 Kron m/dubbel impuls skruv 18 943 62 D-trapp m/d-impuls</p>	<p>5 5 5</p>	<p>Alu Alu Alu</p>
	<p>18 905 59 Brytare infälld 3x1 pol snabb</p>	<p>5</p>	<p>Alu</p>
	<p>18 942 31 2+1 skruv</p>	<p>5</p>	<p>Alu</p>
	<p>18 942 32 2+2 skruv</p>	<p>5</p>	<p>Alu</p>
	<p>18 942 33 Jalousibrytare snabb</p>	<p>5</p>	<p>Alu</p>

E-nr



Beskrivning







Förp. Färg

VIPPOR + TILBEHÖR LISTA 18



	18 942 34 Vippa m/fönster	5	Alu
	18 943 57 Vippa kron m/fönster	5	Alu
	18 900 34 Vippa m/fönster „nyckel”	5	Alu
	18 900 35 Vippa m/fönster „klocka”	5	Alu
	18 900 36 Vippa m/fönster „ljus”	5	Alu

STRÖMBRYTARE UTANPÅLIGGANDE SKRUV 16A ALU LISTA 18



	18 905 70 Trapp loft utv	5	Alu
	18 905 73 Kors Loft utv	5	Alu
	18 906 03 Impuls utv	5	Alu
	1890571 Kron Loft utv	5	Alu
	1890572 2-pol Loft utv	5	Alu

	E-nr	Beskrivning	Förp.	Färg
	18 942 37	Trapp skruv	5	Antracit
	18 942 39	Kors skruv	5	Antracit
	18 942 40	Impuls skruv	5	Antracit
	18 942 35	2-pol skruv	5	Antracit
	18 942 42	Kron m/1 impuls skruv	5	Antracit
	18 942 43	Kron m/dubbel impuls skruv	5	Antracit
	18 943 63	D-trapp m/d-impuls	5	Antracit
	18 905 61	Bryter inf 16/3x1 pol snabb	5	Antracit
	18 942 44	2+1 skruv	5	Antracit
	18 942 45	2+2 skruv	5	Antracit
	18 942 46	Jalusibrytare snabb	5	Antracit

VIPPOR + TILBEHÖR LISTA 18

	E-nr	Beskrivning	Förp.	Färg
	18 942 47	Vippra m/fönster	5	Antracit
	18 943 58	Vippra kron m/fönster	5	Antracit
	18 900 37	Vippra m/fönster „nyckel“	5	Antracit
	18 900 38	Vippra m/fönster „klocka“	5	Antracit
	18 900 39	Vippra m/fönster „ljus“	5	Antracit

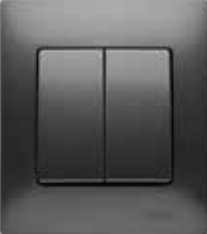
STRÖMBRYTARE UTANPÅLIGGANDE SKRUV 16A ANTRACIT LISTA 18



	18 905 75	Trapp loft utv	5	Antracit
	18 905 78	Kors Loft utv	5	Antracit
	18 906 04	Impuls utv	5	Antracit
	18 905 76	Kron Loft utv	5	Antracit
	18 905 77	2-pol Loft utv	5	Antracit

E-nr

Beskrivning

Förp. Färg

HOTELLKORTS BRYTARE LISTA 18

	18 942 48 Hotellkorts brytare	5	Vit
	18 942 49 Hotellkorts brytare	5	Alu
	18 942 50 Hotellkorts brytare	5	Antracit

Simon **54**
LOFT



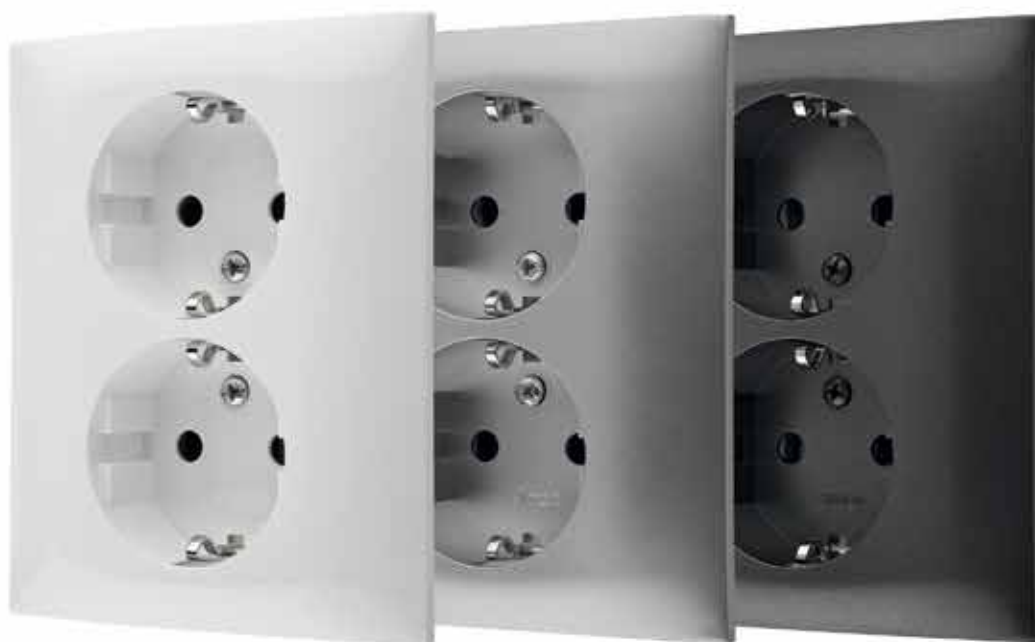

1½ uttaget, med sin uppskattade design, levereras i 3 färger (Vit, Alu och Antracit).



I de fall inte 1½ dosa finns, kan vägguttagen fås med samma frontdesign för vanlig dosa.

Ny mekanism. Du kan välja mellan snabb eller skruvkoppling.

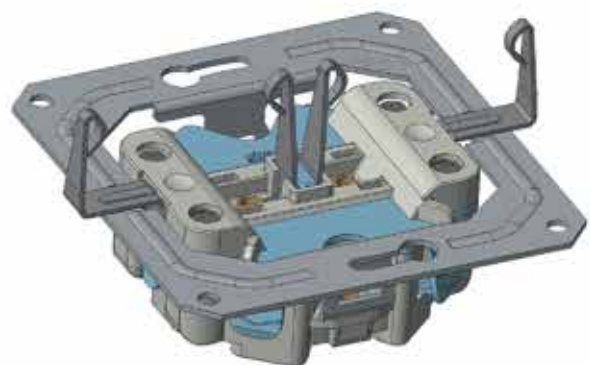
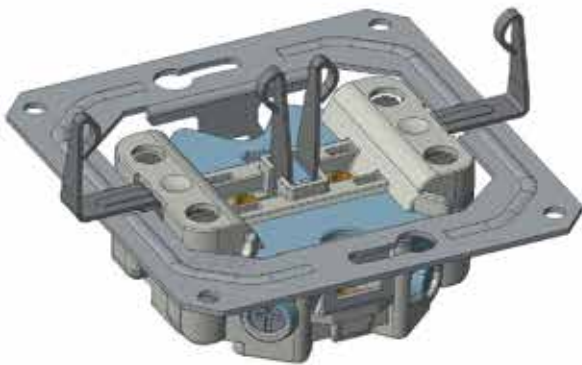

Jordning och petskydd sitter på sockeln, och medger en säker installation även innan plastkåpan är påskruvad.

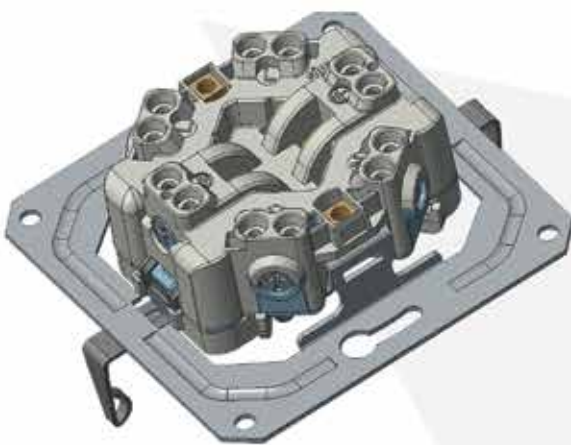







Skruvarna sitter lättåtkomligt på sidan, för snabbt montage.



Den nya snabbkopplingen är säker och enkel att installera snabbt.

Med kontaktering rakt bakifrån, blir det snabbt och enkelt, med bra plats i dosan.

VÄGGUTTAG 16A SKRUVANSL./SNABBANSL. LISTA 18

	<p>18 942 51 1-vägs inf jord skruv</p> <p>18 942 52 1-vägs inf jord snabb</p>	10	Vit
	<p>18 900 47 1-vägs IP44 inf jord skruv</p>	10	Vit
	<p>18 935 02 2-vägs inf jord skruv</p> <p>18 935 18 2-vägs inf jord skruv m/klor</p> <p>18 935 04 2-vägs inf jord snabb</p> <p>18 935 16 2-vägs inf jord snabb m/klor</p> <p>18 904 76 2-vägs inf jord x-plint snabb</p>	10	Vit
	<p>18 906 90 Vägguttag 2-v Premium infälld skruv</p> <p>18 905 97 Vägguttag 2-v infälld snabb</p> <p>18 915 22 Vägguttag 2-v Premium infälld skruv nya sockeln</p> <p>18 915 23 Vägguttag 2-v Premium infälld snabb, nya sockeln</p>	10	Vit
	<p>18 900 40 2-vägs inf jord 1,5 låg skruv</p> <p>18 900 42 2-vägs inf jord 1,5 låg snabb</p> <p>18 915 24 Vägguttag 2-v 1,5 låg Premium infälld snabb, nya sockeln</p>	10	Vit
	<p>18 942 63 1-vägs inf ojord skruv</p>	5	Vit
	<p>18 942 64 2-vägs inf ojord skruv</p>	5	Vit







E-nr

Beskrivning

Förp.

Färg

VÄGGUTTAG 16A UTV. LISTA 18

	18 904 67 1-vägs utv jord skruv	10	Vit
	18 901 86 2-vägs utv ojord skruv	10	Vit
	18 935 12 2-vägs utv jord skruv	10	Vit
	18 935 14 2-vägs utv jord snabb	10	Vit
	19 904 77 2-vägs utv jord x-plint snabb	10	Vit
	18 915 34 2-vägs uttag med 2-fack hörnbox	10	Vit
	18 943 73 2-vägs uttag med 2-fack hörnbox	6	Vit
	18 935 37 4-Vägs utv jord skruv	6	Vit
	18 935 41 4-Vägs utv jord snabb	6	Vit
	18 904 78 4-Vägs utv jord x-plint snabb	6	Vit

VÄGGUTTAG 16A PREMIUM LISTA 18

	18 900 43 6-vägs inf m/multidosa	5	Vit
	18 900 44 6-vägs+2xKat 6 inf m/multidosa	5	Vit
	18 900 58 4-vägs+2xKat 6 inf m/multidosa	5	Vit

FÖRHÖJNINGSRAMAR LISTA 18







	18 901 34 Förhöjningsram 3 modul 55mm	5	Vit
	18 901 35 Förhöjningsram 4 modul 55mm	5	Vit

E-nr





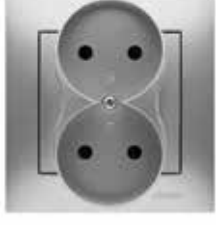

Beskrivning

Förp. Färg

VÄGGUTTAG INF. 16A SKRUVANSL. LISTA 18

	18 942 53 1-vägs inf jord skruv	5	Alu
	18 900 48 1-vägs IP 44 inf jord skruv	5	Alu
	18 942 54 2-vägs inf jord skruv	10	Alu
	18 905 98 Vägguttag 2-v inf skruv	10	Alu
	18 915 25 Vägguttag 2-v Premium infälld skruv nya sockeln	10	Alu
	18 915 27 Vägguttag 2-v Premium infälld snabb, nya sockeln	10	Alu
	18 900 45 2-vägs inf jord 1,5 låg skruv	10	Alu
	18 915 28 Vägguttag 2-v 1,5 låg Premium infälld snabb, nya sockeln	10	Alu
	18 942 66 2-vägs inf ojord skruv	5	Alu
	18 942 65 1-vägs inf ojord skruv	5	Alu

VÄGGUTTAG UTV. 16A SKRUVANSL. LISTA 18

	18 904 68 1-vägs utv jord skruv	10	Alu
	18 903 10 2-vägs utv ojord skruv	5	Alu
	18 942 55 2-vägs utv jord skruv	10	Alu
	18 915 35 2-vägs uttag med 2-fack hörnbox	10	Alu
	18 943 74 2-vägs uttag med 2-fack hörnbox	6	Alu
	18 942 56 4-Vägs utv jord skruv	6	Alu

E-nr



Beskrivning

Förp. Färg







VÄGGUTTAG 16A PREMIUM LISTA 18

	18 901 95 6-vägs inf m/multidosa	5	Alu
	18 901 96 6-vägs+2xKat 6 inf m/multidosa	5	Alu
	18 901 37 4-vägs+2xKat 6 inf m/multidosa	5	Alu

FÖRHÖJNINGSRAMAR LISTA 18

	18 901 38 Förhöjningsram 3 modul 55mm	5	Alu
	18 901 74 Förhöjningsram 4 modul 55mm	5	Alu

VÄGGUTTAG INF. 16A SKRUVANSL. LISTA 18

	18 942 57 1-vägs inf jord skruv	5	Antracit
	18 900 49 1-vägs IP 44 inf jord skruv	5	Antracit
	18 942 58 2-vägs inf jord skruv	10	Antracit
	18 905 99 Vägguttag 2-v inf Premium skruv	10	Antracit
	18 915 29 Vägguttag 2-v Premium infälld skruv nya sockeln	10	Antracit
	18 915 30 Vägguttag 2-v Premium infälld snabb, nya sockeln	10	Antracit
	18 900 46 2-vägs inf jord 1,5 låg skruv	10	Antracit
	18 915 33 Vägguttag 2-v 1,5 låg Premium infälld snabb, nya sockeln	10	Antracit
	18 942 67 1-vägs inf ojord skruv	5	Antracit
	18 942 68 2-vägs inf ojord skruv	5	Antracit







E-nr

Beskrivning

Förp.

Färg



VÄGGUTTAG UTV. 16A SKRUVANSL. LISTA 18

	18 904 70 1-vägs utv jord skruv	10	Antracit
	18 904 65 2-vägs utv ojord skruv	5	Antracit
	18 942 59 2-vägs utv jord skruv	10	Antracit
	18 915 36 2-vägs uttag med 2-fack hörnbox	6	Antracit
	18 943 75 2-vägs uttag med 2-fack hörnbox	6	Antracit
	18 942 60 4-Vägs utv jord skruv	6	Antracit

VÄGGUTTAG 16A PREMIUM LISTA 18

	18 901 97 6-vägs inf m/multidosa	5	Antracit
	18 901 98 6-vägs+2xKat 6 inf m/multidosa	5	Antracit
	18 901 75 4-vägs+2xKat 6 inf m/multidosa	5	Antracit

FÖRHÖJNINGSRAMAR LISTA 18

	18 901 78 Förhöjningsram 3 modul 55mm	5	Antracit
	18 901 79 Förhöjningsram 4 modul 55mm	5	Antracit





E-nr

Beskrivning

Förp.

Färg

TIMER LISTA 18

	<p>18 975 70 Timer inf 10A, TID 1-99 min Timer 2000 W/8 A. Tidsinställningar kan manuell förbikopplas. Funktion visas med LED indikator.</p>	4	Vit
	<p>18 975 71 Timer inf 10A, TID 1-99 min Timer 2000 W/8 A. Tidsinställningar kan manuell förbikopplas. Funktion visas med LED indikator.</p>	4	Alu
	<p>18 975 72 Timer inf 10A, TID 1-99 min Timer 2000 W/8 A. Tidsinställningar kan manuell förbikopplas. Funktion visas med LED indikator.</p>	4	Antracit
	<p>18 972 39 Timer kit, TID 1-99 min Timer 2000 W/8 A. Tidsinställningar kan manuellt förbikopplas. Funktion visas med LED indikator.</p>	1	Vit
	<p>18 943 72 Timer kit m/hörnbox, TID 1-99 min Timer 2000 W/8 A. Tidsinställningar kan manuellt förbikopplas. Funktion visas med LED indikator.</p>	1	Vit

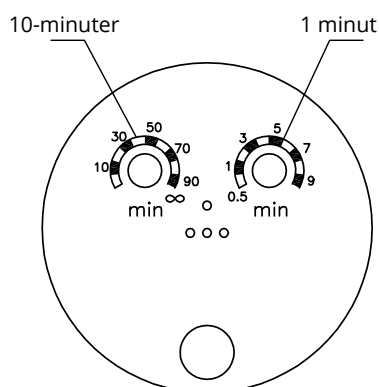





































E-nr

Beskrivning







Förp. Färg







KOMBINATIONSRAMAR LISTA 18







	18 943 00		40	Vit
	18 943 02		25	Vit
	18 943 03		20	Vit
	18 943 04		20	Vit
	18 943 05		20	Vit
	18 943 06		40	Alu
	18 943 07		25	Alu
	18 943 08		20	Alu
	18 943 09		20	Alu
	18 943 10		20	Alu
	18 943 11		40	Antracit
	18 943 12		25	Antracit
	18 943 13		20	Antracit
	18 943 14		20	Antracit
	18 943 15		20	Antracit
	18 943 21		15	Metal inox
	18 943 22		15	Metal inox
	18 943 23		15	Metal inox
	18 943 24		15	Metal inox
	18 943 25		15	Metal copper
	18 943 26		15	Metal copper
	18 943 27		15	Metal copper
	18 943 28		15	Metal copper
	18 943 29		15	Metal chrome
	18 943 30		15	Metal chrome
	18 943 31		15	Metal chrome
	18 943 32		15	Metal chrome







E-nr	Beskrivning	Förp.	Färg
18 943 33		15	Dark steel
18 943 34		15	Dark steel
18 943 35		15	Dark steel
18 943 36		15	Dark steel







SIMON 54 NATURE BETONG RAMMER LISTA 18







	18 912 41		10	Light concrete/white
	18 912 42		5	Light concrete/white
	18 912 43		5	Light concrete/white
	18 912 44		5	Light concrete/white
	18 912 46		5	Light concrete/white

	18 912 48		10	Light concrete/alu
	18 912 50		5	Light concrete/alu
	18 912 51		5	Light concrete/alu
	18 912 52		5	Light concrete/alu
	18 912 53		5	Light concrete/alu

	18 912 54		10	Light concrete/antracit
	18 912 55		5	Light concrete/antracit
	18 912 56		5	Light concrete/antracit
	18 912 57		5	Light concrete/antracit
	18 912 58		5	Light concrete/antracit

	18 912 59		10	Dark concrete/white
	18 912 60		5	Dark concrete/white
	18 912 61		5	Dark concrete/white
	18 912 62		5	Dark concrete/white
	18 912 63		5	Dark concrete/white

	18 912 65		10	Dark concrete/alu
	18 912 66		5	Dark concrete/alu
	18 912 67		5	Dark concrete/alu
	18 912 68		5	Dark concrete/alu
	18 912 69		5	Dark concrete/alu







	18 912 74		10	Dark concrete/antracit
	18 912 75		5	Dark concrete/antracit
	18 912 76		5	Dark concrete/antracit
	18 912 77		5	Dark concrete/antracit
	18 912 78		5	Dark concrete/antracit

E-nr

















Beskrivning

Förp. Färg

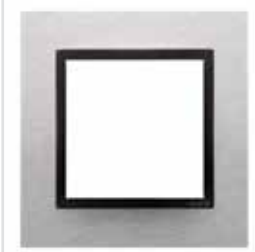

SIMON 54 NATURE GLASRAMAR LISTA 18

	18 900 59	<input type="checkbox"/>	10	White Pearl
	18 900 60	<input type="checkbox"/>	5	White Pearl
	18 900 61	<input type="checkbox"/>	5	White Pearl
	18 900 62	<input type="checkbox"/>	5	White Pearl
	18 905 84	<input type="checkbox"/>	5	White Pearl
	18 900 63	<input type="checkbox"/>	10	Frozen Lava
	18 900 64	<input type="checkbox"/>	5	Frozen Lava
	18 900 65	<input type="checkbox"/>	5	Frozen Lava
	18 900 74	<input type="checkbox"/>	5	Frozen Lava
	18 905 85	<input type="checkbox"/>	5	Frozen Lava
	18 900 77	<input type="checkbox"/>	10	Silver Fog
	18 900 78	<input type="checkbox"/>	5	Silver Fog
	18 900 79	<input type="checkbox"/>	5	Silver Fog
	18 900 99	<input type="checkbox"/>	5	Silver Fog
	18 905 86	<input type="checkbox"/>	5	Silver Fog
	18 901 00	<input type="checkbox"/>	10	Stormy Cloud
	18 901 02	<input type="checkbox"/>	5	Stormy Cloud
	18 901 04	<input type="checkbox"/>	5	Stormy Cloud
	18 901 05	<input type="checkbox"/>	5	Stormy Cloud
	18 905 87	<input type="checkbox"/>	5	Stormy Cloud
	18 902 10	<input type="checkbox"/>	10	Lunar Lava
	18 902 12	<input type="checkbox"/>	5	Lunar Lava
	18 902 14	<input type="checkbox"/>	5	Lunar Lava
	18 902 15	<input type="checkbox"/>	5	Lunar Lava
	18 905 88	<input type="checkbox"/>	5	Lunar Lava
	18 902 18	<input type="checkbox"/>	10	Tempting Plum
	18 902 24	<input type="checkbox"/>	5	Tempting Plum
	18 902 25	<input type="checkbox"/>	5	Tempting Plum
	18 902 26	<input type="checkbox"/>	5	Tempting Plum
	18 905 89	<input type="checkbox"/>	5	Tempting Plum
	18 902 27	<input type="checkbox"/>	10	Lime Sorbet
	18 902 28	<input type="checkbox"/>	5	Lime Sorbet
	18 902 29	<input type="checkbox"/>	5	Lime Sorbet
	18 902 30	<input type="checkbox"/>	5	Lime Sorbet
	18 905 90	<input type="checkbox"/>	5	Lime Sorbet







SIMON 54 NATURE STÅLRAMAR LISTA 18

	18 901 17		10	Classic Inox
	18 901 18		5	Classic Inox
	18 901 19		5	Classic Inox
	18 901 20		5	Classic Inox
	18 905 91		5	Classic Inox
	18 902 32		10	Satin Glare
	18 902 33		5	Satin Glare
	18 902 34		5	Satin Glare
	18 902 37		5	Satin Glare
	18 905 92		5	Satin Glare
	18 902 38		10	Satin Dusk
	18 902 39		5	Satin Dusk
	18 902 49		5	Satin Dusk
	18 902 56		5	Satin Dusk
	18 905 93		5	Satin Dusk
	18 902 57		10	Inox Yin
	18 902 58		5	Inox Yin
	18 902 59		5	Inox Yin
	18 902 63		5	Inox Yin
	18 905 94		5	Inox Yin
	18 902 64		10	Inox Yang
	18 902 97		5	Inox Yang
	18 902 98		5	Inox Yang
	18 902 99		5	Inox Yang
	18 905 95		5	Inox Yang

SIMON 54 NATURE TRÄRAM LISTA 18



	18 901 07		10	Silver Wenge
	18 901 08		5	Silver Wenge
	18 901 09		5	Silver Wenge
	18 901 10		5	Silver Wenge
	18 905 96		5	Silver Wenge

DJUPA RAMAR LISTA 18

	18 943 64 	1-facks ram djup	40	Vit
	18 943 65 	2-facks ram djup	25	Vit
	18 943 66 	3-facks ram djup	20	Vit
	18 943 67 	4-facks ram djup	20	Vit
	18 943 68 	5-facks ram djup	20	Vit

Specialramar för t.ex. ojämna väggar eller montage med multidosaKombinationsramar
standardKombinationsramar
special 3 mm

IP44 MEMBRAN (FÖR RAMAR) GRUPPE 14

	18 942 93 Membran för 1-facks ram <input type="checkbox"/>
	18 942 95 Membran för 2-facks ram <input type="checkbox"/>
	18 942 96 Membran för 3-facks ram <input type="checkbox"/>
	18 942 97 Membran för 4-facks ram <input type="checkbox"/>
	18 942 98 Membran för 5-facks ram <input type="checkbox"/>
	18 942 99 Tätningsskydd för kron IP 44

BLINDLOCK LISTA 18

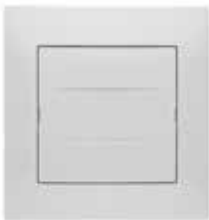
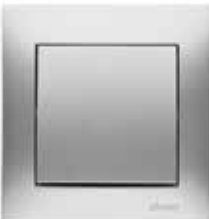
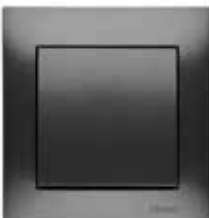





	18 942 78 Blindlock	10	Vit
	18 942 79 Blindlock	5	Alu
	18 942 80 Blindlock	5	Antracit

E-nr

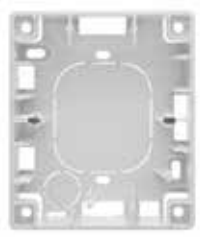

Beskrivning

Förp. Färg

FÖRHÖJNINGSRAMAR LISTA 18

	18 942 81 1-facksram 35mm <input type="checkbox"/>	20	Vit
	18 942 82 2-facksram 35mm <input type="checkbox"/> <input type="checkbox"/>	10	Vit
	18 942 83 3-facksram 35mm <input type="checkbox"/> <input type="checkbox"/> <input type="checkbox"/>	6	Vit
	18 943 69 Hörnbox 2-fack	6	Vit
	18 942 90 Ram för 2-vägs uttag inf	10	Vit
	18 942 84 1-facksram 35mm <input type="checkbox"/>	20	Alu
	18 942 85 2-facksram 35mm <input type="checkbox"/> <input type="checkbox"/>	20	Alu
	18 942 86 3-facksram 35mm <input type="checkbox"/> <input type="checkbox"/> <input type="checkbox"/>	20	Alu
	18 943 70 Hörnbox 2-fack	6	Alu
	18 942 91 Ram för 2-vägs uttag inf	5	Alu

E-nr Beskrivning Förp. Färg







	<p>18 942 87 1-facksram 35mm <input type="checkbox"/></p> <p>18 942 88 2-facksram 35mm <input type="checkbox"/> <input type="checkbox"/></p> <p>18 942 89 3-facksram 35mm <input type="checkbox"/> <input type="checkbox"/> <input type="checkbox"/></p>	<p>20</p> <p>10</p> <p>6</p>	<p>Antracit</p> <p>Antracit</p> <p>Antracit</p>
	<p>18 943 71 Hörnbox 2-fack</p>	<p>6</p>	<p>Antracit</p>
	<p>18 942 92 Ram för 2-vägs uttag inf</p>	<p>6</p>	<p>Antracit</p>

SIDA 50 MODULARUTTAG KEYSTONE
SIDA 51 MODULARJACK LÖS
SIDA 54 USB LADDARE

LISTA 51

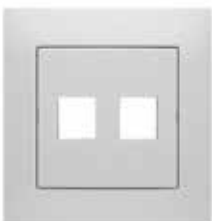
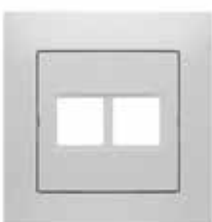

MODULARUTTAG KEYSTONE LISTA 51



	51 184 00 1xKat6 3M UTP don Keystone hålbild Verktøysløs anslutning Med dammlucka	10	Vit
	51 184 01 2xKat6 3M UTP don Keystone hålbild Verktøysløs anslutning Med dammlucka	10	Vit
	51 184 02 Centrumsplatta 2-hål Keystone hålbild	10	Vit
	51 184 14 Centrumplatta 2-hål Lex Com	10	Vit
	51 184 03 Centrumsplatta 1-hål (vinkel) Keystone hålbild	10	Vit
	51 175 05 Centrumplatta 2-hål (vinkel) Keystone hålbild	10	Vit
	51 185 21 Blindpropp til mod. Uttag	20	Vit







E-nr





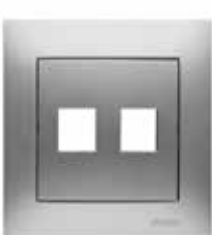
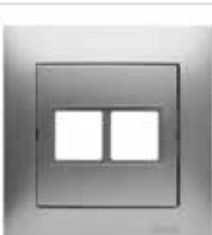

Beskrivning

Förp. Färg



MODULARJACK LÖS LISTA 51

	51 400 34 Modularjack Kat6 3M UTP Vit Keystone hålbild Verktygslös anslutning Med dammlucka	10
	51 400 31 Modularjack Kat6 3M UTP Svart Keystone hålbild Verktygslös anslutning Med dammlucka	10

E-nr	Beskrivning	Förp.	Färg
	51 184 04 1xKat6 3M UTP don Keystone hålbild Verktyslös anslutning Med dammlucka	5	Alu
	51 184 05 2xKat6 3M UTP don Keystone hålbild Verktyslös anslutning Med dammlucka	5	Alu
	51 184 06 Centrumsplatta 2-hål Keystone hålbild	5	Alu
	51 184 15 Centrumplatta 2-hål Lex Com	5	Alu
	51 184 07 Centrumsplatta 1-hål (vinkel) Keystone hålbild	5	Alu
	51 175 07 Centrumplatta 2-hål (vinkel) Keystone hålbild	5	Alu
	51 184 08 Blindpropp til mod. Uttag	10	Alu

E-nr	Beskrivning	Förp.	Färg
	51 184 09 1xKat6 3M UTP don Keystone hålbild Verktyglös anslutning Med dammlucka	5	Antracit
	51 184 10 2xKat6 3M UTP don Keystone hålbild Verktyglös anslutning Med dammlucka	5	Antracit
	51 184 11 Centrumsplatta 2-hål Keystone hålbild	5	Antracit
	51 184 16 Centrumsplatta 2-hål Lex Com	5	Antracit
	51 184 12 Centrumsplatta 1-hål (vinkel) Keystone hålbild	5	Antracit
	51 175 09 Centrumsplatta 2-hål (vinkel) Keystone hålbild	5	Antracit
	51 184 13 Blindpropp til mod. Uttag	10	Antracit

USB LADDARE LISTA 51

	<p>51 174 83 Laddare 2xUSB 2,1A</p>	<p>5</p>	<p>Vit</p>
	<p>51 174 87 Laddare 2xUSB 2,1A</p>	<p>5</p>	<p>Alu</p>
	<p>51 174 95 Laddare 2xUSB 2,1A</p>	<p>5</p>	<p>Antracit</p>

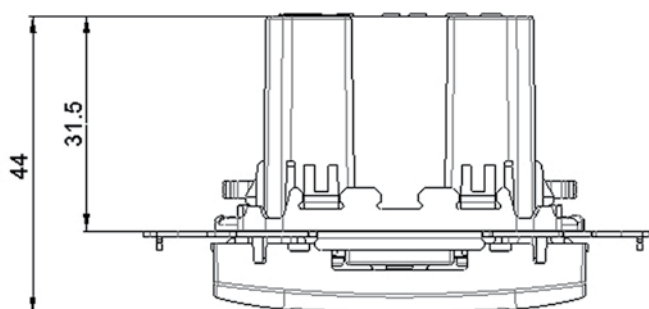
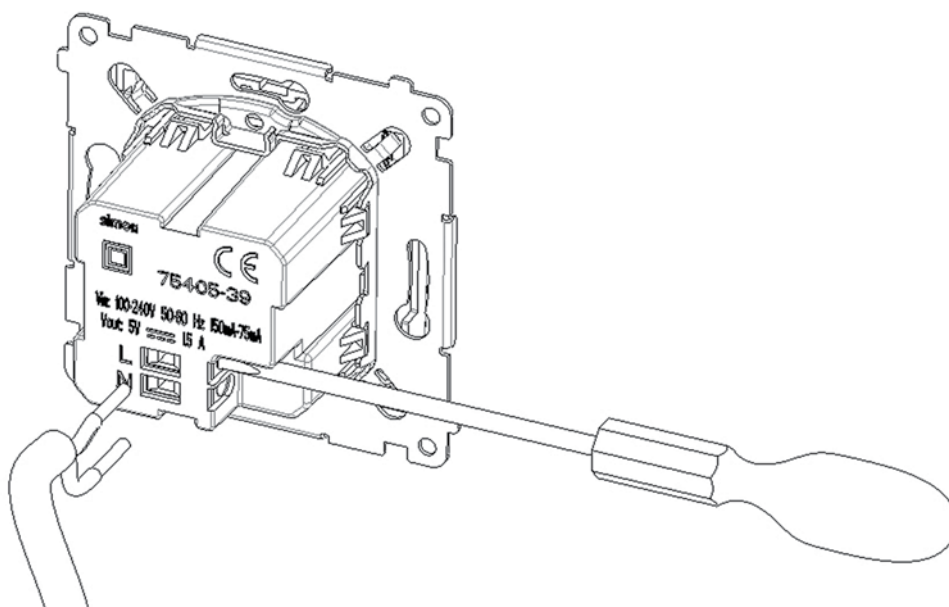

KONTAKT simon



























Simon 54
Premium



LISTA 60



ANTENNUTTAG LISTA 60

	60 701 70 Serieuttag 10dB  TV IEC, 5÷70 MHz, 120÷862 MHz, 10 dB  R IEC 88÷108 MHz, 11 dB	5	Vit
	60 701 71 Slututtag 1,5dB  TV IEC, 5÷70 MHz, 120÷862 MHz, 1 dB  R IEC 88÷108 MHz, 1,5 dB	5	Vit
	60 701 72 Slututtag 10dB  TV IEC, 5÷70 MHz, 120÷862 MHz, 10 dB  R IEC 88÷108 MHz, 11 dB	5	Vit
	69 701 73 Sat uttag m/slututtag 10dB  SAT „F“, 950 MHz±2,4 GHz, 8 dB  TV IEC, 5÷70 MHz, 120÷862 MHz, 12 dB  R IEC 88÷108 MHz, 12 dB	5	Vit
	60 701 75 Centrumplatta tv/rad norden	20	Vit
	60 701 77 Centrumplatta tv/rad/sat norden	20	Vit
	60 701 78 Serieuttag 10dB  TV IEC, 5÷70 MHz, 120÷862 MHz, 10 dB  R IEC 88÷108 MHz, 11 dB	5	Alu
	60 701 79 Slututtag 1,5dB  TV IEC, 5÷70 MHz, 120÷862 MHz, 1 dB  R IEC 88÷108 MHz, 1,5 dB	5	Alu
	60 701 80 Slututtag 10dB  TV IEC, 5÷70 MHz, 120÷862 MHz, 10 dB  R IEC 88÷108 MHz, 11 dB	5	Alu
	60 701 81 Sat uttag m/slututtag 10dB  SAT „F“, 950 MHz±2,4 GHz, 8 dB  TV IEC, 5÷70 MHz, 120÷862 MHz, 12 dB  R IEC 88÷108 MHz, 12 dB	5	Alu

E-nr Beskrivning Förp. Färg

	<p>60 701 83 Centrumplatta tv/rad norden</p>	5	Alu
	<p>60 701 85 Centrumplatta tv/rad/sat norden</p>	5	Alu
	<p>60 701 86 Serieuttag 10dB  TV IEC, 5÷70 MHz, 120÷862 MHz, 10 dB  R IEC 88÷108 MHz, 11 dB</p> <p>60 701 87 Slututtag 1,5dB  TV IEC, 5÷70 MHz, 120÷862 MHz, 1 dB  R IEC 88÷108 MHz, 1,5 dB</p> <p>60 701 88 Slututtag 10dB  TV IEC, 5÷70 MHz, 120÷862 MHz, 10 dB  R IEC 88÷108 MHz, 11 dB</p>	5	Antracit
	<p>69 701 89 Antennekontakt tv/rad/sat ende 10dB  SAT „F“, 950 MHz÷2,4 GHz, 8 dB  TV IEC, 5÷70 MHz, 120÷862 MHz, 12 dB  R IEC 88÷108 MHz, 12 dB</p>	5	Antracit
	<p>60 701 91 Centrumplatta tv/rad norden</p>	5	Antracit
	<p>60 701 93 Centrumplatta tv/rad/sat norden</p>	5	Antracit

LISTA 62





E-nr



Beskrivning

Förp. Färg

HÖGTALARUTTAG LISTA 62

	62 402 10 Högtalaruttag	5	Vit
	62 402 11 Högtalaruttag	5	Alu
	62 402 12 Högtalaruttag	5	Antracit

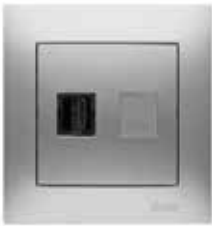
HDMI UTTAG LISTA 62



	62 402 13 HDMI uttag	5	Vit
	62 402 14 HDMI uttag	5	Alu
	62 402 15 HDMI uttag	5	Antracit

E-nr

Beskrivning

Förp. Färg

ANSLUTNINGSLOCK LISTA 62

	62 402 16 Anslutningslock	5	Vit
	62 402 17 Anslutningslock	5	Alu
	62 402 18 Anslutningslock	5	Antracit







Simon **54**

LISTA 85



TERMOSTAT LISTA 85

	85 802 86 Simon multitermostat 1 pol 16A max 3600W	10	Vit
	85 802 87 Simon multitermostat 1 pol 16A max 3600W	5	Alu
	85 802 88 Simon multitermostat 1 pol 16A max 3600W	5	Antracit

E-nr	Beskrivning	Förp.	Färg
	85 802 80 Termostat m/luftsensor 2 pol 16A max 3600w 5-40°C	10	Vit
	85 802 82 Termostat m/luftsensor 2 pol 16A max 3600w 5-40°C	5	Alu
	85 802 84 Termostat m/luftsensor 2 pol 16A max 3600w 5-40°C	5	Antracit

DEMO LÅDA LISTA 85

	95 902 24 Demo låda Simon 54 Premium	1	
---	---	---	--

Simon X4 Protector







KONTAKT SIMON

Importör:
Kontakt-Simon Nordic AS
Hjalmar Bjørgesvei 105
1604 Fredrikstad
Norge
Tlf 0047 9040 5758
E-mail: post@kontaktsimon.no
www.kontaktsimon.se