

LINK

SYSTEM



Bracket up to 10 m high made up of a telescopic pole and various arm models with fixing clamp.

All light points are supplied with the 2 components parts: bracket and arm. Supports are available in 2 basic heights: 8 and 10 m. The system also offers the possibility of supplying light points of other heights.

There are two main parts which differentiate the Link System. On the one hand, the clamp. This part enables the arm to be secured to the pole without screws, but gives the assembly a highly integrated quality. There are two types of clamp available: lateral and frontal depending on the arm fixing design.

On the other hand, there is the arm, the design and characteristics of which determine the light point model.

The LINK System is made up of three series for the three basic settings to be found in modern-day cities.

TECH (technical) Series

with a technical, minimalist appearance to merge with the aesthetics of modern architecture. It is made up of the arms: Qtech and Linetech.

CLAS (classic) Series

with more classic, traditional lines. This series is designed for historical areas of cities. It is made up of the arms: Ecoclas and Classic.

DEC (decorative) Series

perfect for urban landscapes where there is a desire to add a design touch. It is made up of the arms: Ecodec, Sdec and Rdec.

TECH SERIES

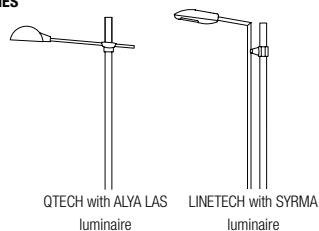

CLAS SERIES

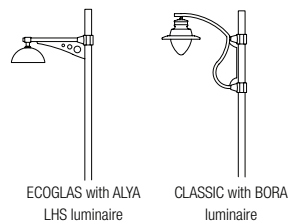

DEC SERIES

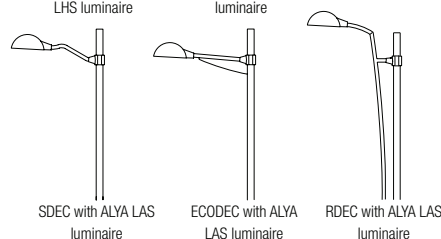

Pole materials

Shaft:

carbon steel plate.

Flange plate:

flat steel plate with reinforcing ring and gussets.

Pole finish

Hot dip galvanised.

Pole IP/IK

IP 3X.

To achieve IP44, use of an internal junction box with IP44 is necessary (not supplied with the pole).

IK 10

Notes

Supplied with fixing bolts and template.
Luminaires not included.

Clamp material

Die-cast aluminium

TECHNICAL DATA SHEET

FINISH	see finishes for each model
SHAFT	telescopic, 168 mm major diameter, 115 mm minor diameter, galvanised
TRAPDOOR	Flush
CERTIFICATION	conforms to: EN 40-5 STANDARD

TECHNICAL DATA

Ød	ØD	DOOR			FLANGE PLATE		BOLTS	
		X	Y	Z	A	B	Metric	Length
115	168	137	310	545	285	400	M22	600

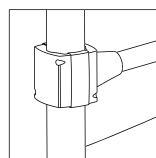
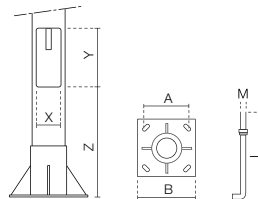

FRONTAL CLAMP

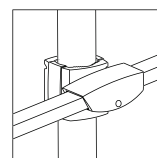

LATERAL CLAMP

ACCESSORIES

ACCESSORIES	CODE	DESCRIPTION
Link 200 bktech banderole	5-630102	LINK BANDEROLE 200 D76-115 BKTECH
Link 200 bkclas banderole	5-630202	LINK BANDEROLE 200 D76-115 BKCLAS

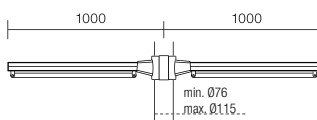

TECH SERIES: QTECH MODELS

MODEL	H	ARMS	ORIENT.	1st ARM		2nd ARM		CODE
				H1	L1	H2	L2	
Qtech 100	8000	1	-	7500	1400	-	-	5-640001-051
Qtech 210	8000	2	180°	5000	1000	7500	1400	5-640002-051
Qtech 200	8000	2	180°	7500	1400	7500	1400	5-640003-051
Qtech 101	8000	1	-	7500	1400	-	-	5-640004-051
Qtech 211	8000	2	180°	5000	1000	7500	1400	5-640005-051
Qtech 100	10000	1	-	9500	1400	-	-	5-640006-051
Qtech 210	10000	2	180°	5000	1000	9500	1400	5-640007-051
Qtech 200	10000	2	180°	9500	1400	9500	1400	5-640008-051
Qtech 101	10000	1	-	9500	1400	-	-	5-640009-051
Qtech 211	10000	2	180°	5000	1000	9500	1400	5-640010-051

QTECH	BRACKET FINISH
Luminaire attachment	pole: BKTECH -bottom-
Lateral attachment by Ø60 x 120 mm coupling at the arm end in the horizontal position.	GYTECH -top-
	clamp: BKTECH
	arms: GYTECH

RECOMMENDED LUMINAIRES			
NATH Istanium® LED page 170		ALYA LAS Istanium® LED page 194	
		ALYA LAS page 197	
		SYRMA page 173	

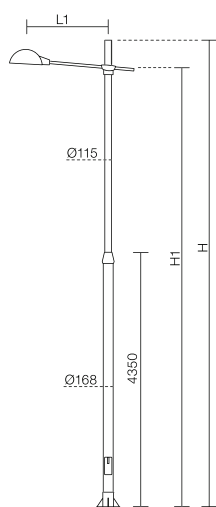

QTECH 100/101
with ALYA LAS luminaire

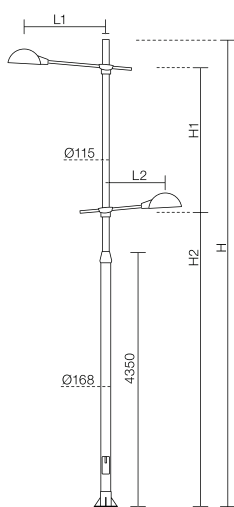

QTECH 210/211
with ALYA LAS luminaires

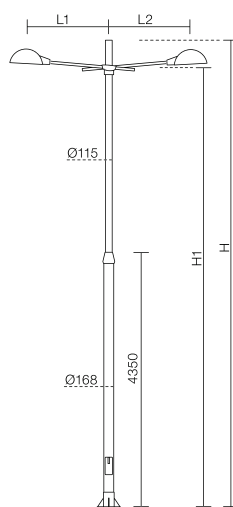

QTECH 200
with ALYA LAS luminaires

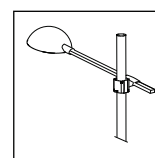

QTECH 100/210

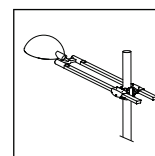

QTECH 101/211

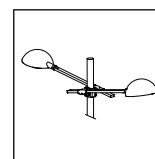

QTECH 200

TECH SERIES: QTech MODELS

MODEL	H	ARMS	ORIENT.	1st ARM		2nd ARM		CODE
				H1	L1	H2	L2	
Linetech 100	8000	1	-	8100	1300	-	-	5-640027-051
Linetech 200	8000	2	180°	8100	1300	8100	1300	5-640028-051
Linetech 100	10000	1	-	10100	1300	-	-	5-640029-051
Linetech 200	10000	2	180°	10100	1300	10100	1300	5-640030-051

LINETECH	BRACKET FINISH
Luminaire attachment Lateral attachment by Ø60 x 120 mm coupling at the arm end in the horizontal position.	pole: ■ BKTECH -bottom- ■ GYTECH -top- clamp: ■ BKTECH arms: ■ GYTECH

RECOMMENDED LUMINAIRES

NATH Istanium® LED page 170		ALYA LAS Istanium® LED page 194		ALYA LAS page 197		SYRMA page 173	
---------------------------------------	---	---	---	-----------------------------	---	--------------------------	---

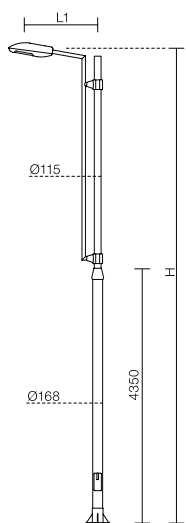



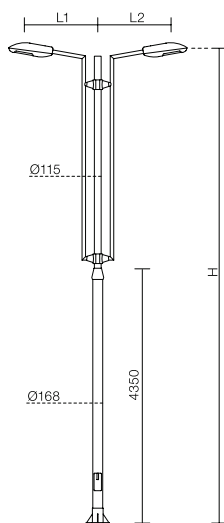

LINETECH 100
with SYRMA luminaire



LINETECH 200
with SYRMA luminaires

CLAS SERIES: ECOCLAS MODELS

MODEL	H	ARMS	ORIENT.	1st ARM		2nd ARM		CODE
				H1	L1	H2	L2	
Ecoclas 100	8000	1	-	7500	1000	-	-	5-640031-014
Ecoclas 210	8000	2	180°	5000	1000	7500	1000	5-640032-014
Ecoclas 200	8000	2	180°	7500	1000	7500	1000	5-640033-014
Ecoclas 100	10000	1	-	9500	1000	-	-	5-640034-014
Ecoclas 210	10000	2	180°	5000	1000	9500	1000	5-640035-014
Ecoclas 200	10000	2	180°	9500	1000	9500	1000	5-640036-014

ECOCLAS	BRACKET FINISH
Luminaire attachment Attachment by 3/4"G thread at the arm end, in the vertical position.	pole:  BKCLAS -bottom-
	 BKCLAS -top-
	clamp:  BKCLAS
	arms:  BKCLAS

RECOMMENDED LUMINAIRES

ALYA LHS Istanium® LED page 194		PRAGA Istanium® LED page 277		ALYA LHS page 197		PRAGA page 280		BORA page 268	
---	---	--	---	-----------------------------	---	--------------------------	---	-------------------------	---

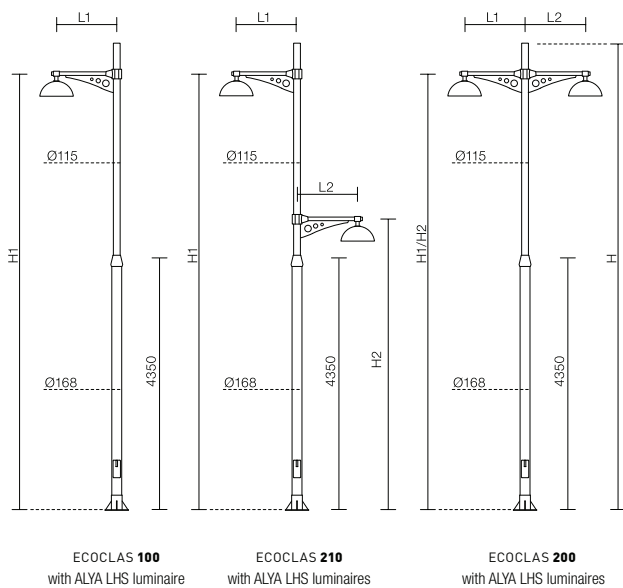





CLAS SERIES: CLASSIC MODELS

MODEL	H	ARMS	ORIENT.	1st ARM		2nd ARM		CODE
				H1	L1	H2	L2	
Classic 100	8000	1	-	7500	1000	-	-	5-640037-014
Classic 210	8000	2	180°	6000	1000	7500	1000	5-640038-014
Classic 200	8000	2	180°	7500	1000	7500	1000	5-640039-014
Classic 100	10000	1	-	9500	1000	10100	1300	5-640040-014
Classic 210	10000	2	180°	6000	1000	9500	1000	5-640041-014
Classic 200	10000	2	180°	9500	1000	9500	1000	5-640042-014

CLASSIC	BRACKET FINISH
Luminaire attachment	pole: ■ BKCLAS -bottom-
Lateral attachment by Ø60 coupling at the arm end in the horizontal position.	■ BKCLAS -top-
	clamp: ■ BKCLAS
	arms: ■ BKCLAS

RECOMMENDED LUMINAIRES

ALYA LHS Istanium® LED page 194		PRAGA Istanium® LED page 277		ALYA LHS page 197		PRAGA page 280		BORA page 268	
---	---	--	---	-----------------------------	---	--------------------------	---	-------------------------	---

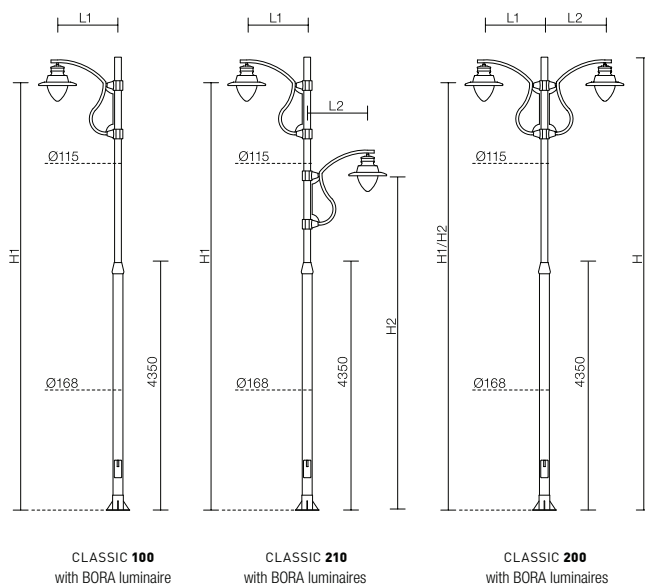

DEC SERIES: SDEC / ECODEC MODELS

MODEL	H	ARMS	ORIENT.	1st ARM		2nd ARM		CODE
				H1	L1	H2	L2	
Sdec 100	8000	1	-	7500	1200	-	-	5-640011-061
Sdec 210	8000	2	180°	5000	1000	7500	1200	5-640012-061
Sdec 200	8000	2	180°	7500	1200	7500	1200	5-640013-061
Sdec 100	10000	1	-	9500	1200	-	-	5-640014-061
Sdec 210	10000	2	180°	5000	1000	9500	1200	5-640015-061
Sdec 200	10000	2	180°	9500	1200	9500	1200	5-640016-061
Ecodec 100	8000	1	-	7500	1400	-	-	5-640017-061
Ecodec 210	8000	2	180°	5000	1000	7500	1400	5-640018-061
Ecodec 200	8000	2	180°	7500	1400	7500	1400	5-640019-061
Ecodec 101	10000	1	-	9500	1400	-	-	5-640020-061
Ecodec 211	10000	2	180°	5000	1000	9500	1400	5-640021-061
Ecodec 200	10000	2	180°	9500	1400	9500	1400	5-640022-061

SDEC	FINISH	ECODEC	FINISH
Luminaire attachment Lateral attachment by Ø60 coupling at the arm end in the horizontal position.	pole: ■ BKCLAS -bottom- ■ GYDECO -top- clamp: ■ BKCLAS arms: ■ GYDECO	Luminaire attachment Lateral attachment by Ø60 coupling at the arm end in the horizontal position.	pole: ■ BKCLAS -bottom- ■ GYDECO -top- clamp: ■ BKCLAS arms: ■ GYDECO



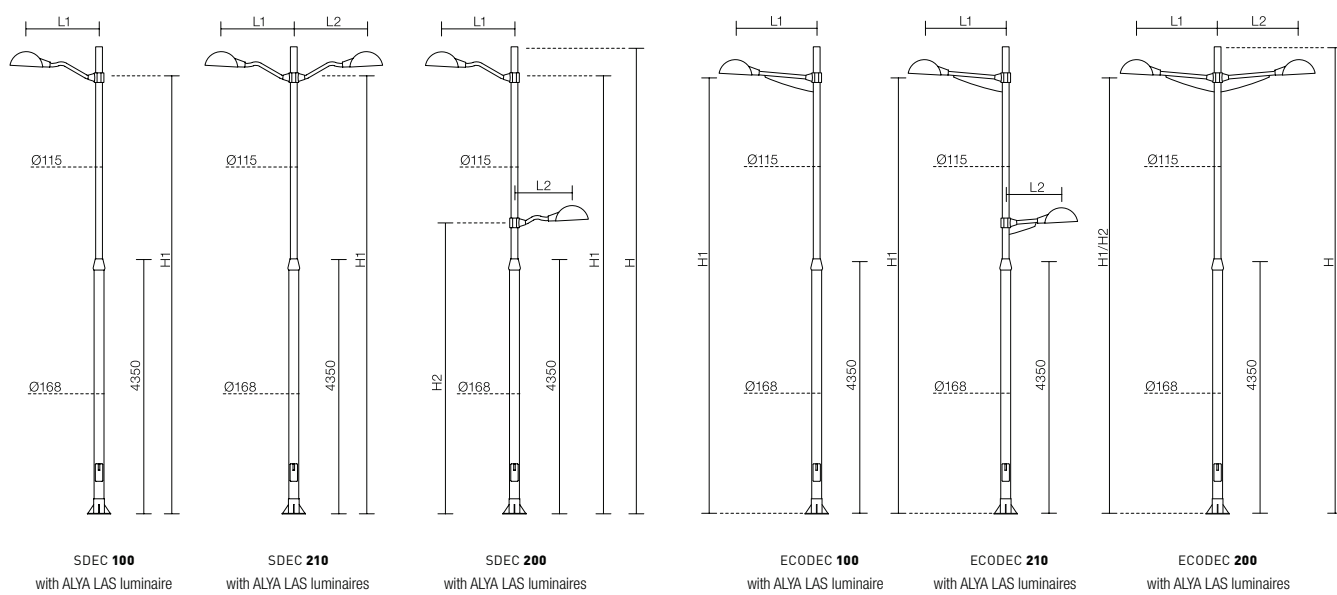

RECOMMENDED LUMINAIRES

NATH Istanium® LED page 170		ALYA LAS Istanium® LED page 194		ALYA LAS page 197		SYRMA page 173	
---------------------------------------	---	---	---	-----------------------------	--	--------------------------	---



DEC SERIES: RDEC MODELS

MODEL	H	ARMS	ORIENT.	1st ARM		2nd ARM		CODE
				H1	L1	H2	L2	
Rdec 100	8000	1	-	8100	1300	-	-	5-640023-061
Rdec 200	8000	2	180°	8100	1300	8100	1300	5-640024-061
Rdec 100	10000	1	-	10100	1300	-	-	5-640025-061
Rdec 200	10000	2	180°	10100	1300	10100	1300	5-640026-061

RDEC	FINISH
Luminaire attachment Lateral attachment by Ø60 coupling at arm end in the horizontal position.	pole:  BKCLAS -bottom-
	 GYDECO -top-
	clamp:  BKCLAS
	arms:  GYDECO

RECOMMENDED LUMINAIRES

<p>NATH Istanium® LED page 170</p> 	<p>ALYA LAS Istanium® LED page 194</p> 	<p>ALYA LAS page 197</p> 	<p>SYRMA page 173</p> 
---	---	---	--

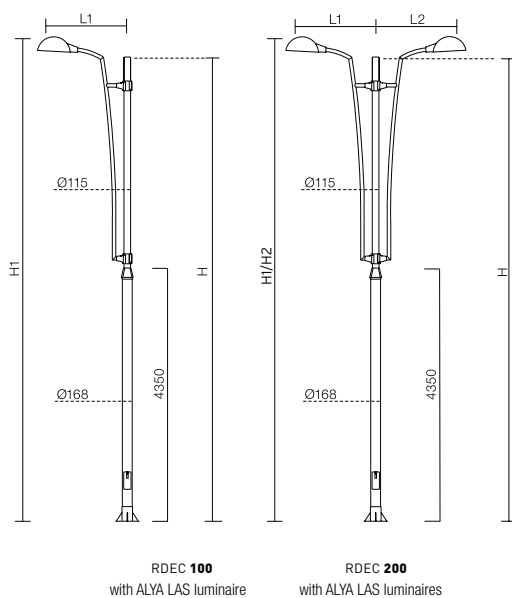

Printed: 2013-07-05